



Asset-Trade

Assessment & Sale of Used Assets

Ref. Nr.: 924-06111039

Overview and Technical Data:

**DECKEL - DMC 60S 6 Achsen
Stangenfräsautomat**

DMG DECKEL

DMG / MORI SEIKI

Baujahr: Jan. 2003



Asset-Trade

Assessment & Sale of Used Assets



Description:

Gebrauchte Deckel Maho DMC 60 S 6-Achsen Stangenfräsautomat

CNC Steuerung: Sinumerik 840 D Powerline - ShopMill.

Betriebsstunden An 31321 / Spindelstunden 11969

- **Verfahrwege**
 - X: 760 mm
 - Y: 460 mm
 - Z: 560 mm
 - A Achse NC-Rundachse
 - B Achse NC-Schwenkfräskopf
 - Kopf schwenkbar +/-: NC
- **Innenkonus: HSK-A 63.**
- **Spindeldrehzahl: 20-12.000 Umdrehungen pro Minute.**
- **Spindeltrieb: 28/19 kW**
- **Werkzeugwechsler mit 60 Plätzen.**
- **Reitstock**
- **Stangenlader Durchmesser 10 bis 105 mm**
- **Stangelader Länge 200 - 1100 mm.**
- **Späneförderer**
- **Maschinenabmessungen: 6 x 5 x 3 m**



Technical Data:

Technical Data:

Steuerung: SINUMERIK 840D
Maschinenstunden: 31.321 Std.
Spindelstunden: 11.969 Std.
Spindeldrehzahl: 12.000 U/Min
Werkzeugkapazität: 60 x

Travels:

X-Achse: 760 mm
Y-Achse: 460mm
Z-Achse: 560 mm

Dimensions and Weight:

Gewicht: 11.000 kg

Buyer Information:

Zustand: Sehr guten Zustand
Verfügbarkeit: Sofort
Verkauft als:
EXW (ab Werk - Incoterm)
MwSt.: 19 %
Käuferaufgeld: 16 %
Standort: Deutschland



Images:



1

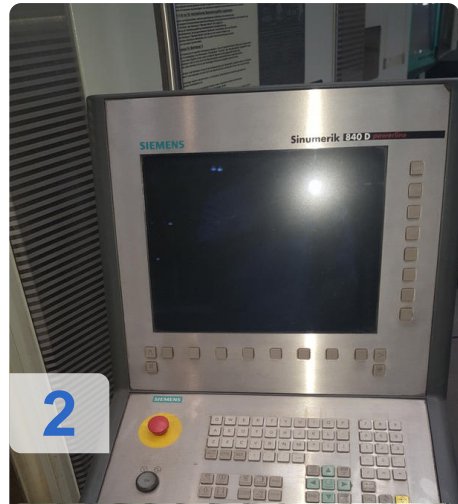

2



3



4



7

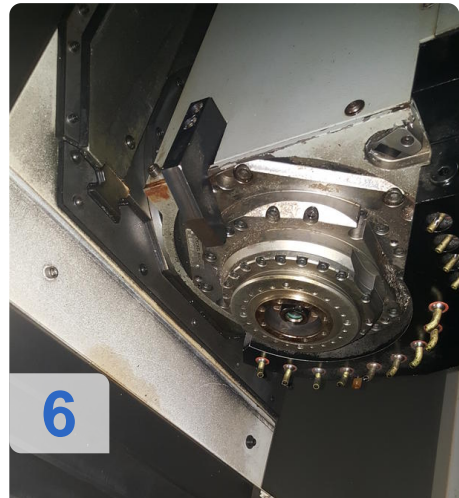



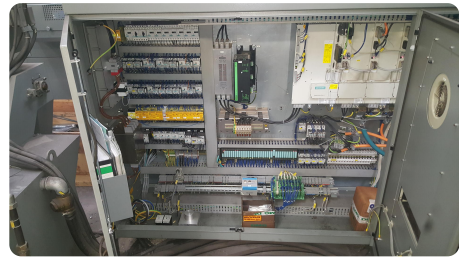
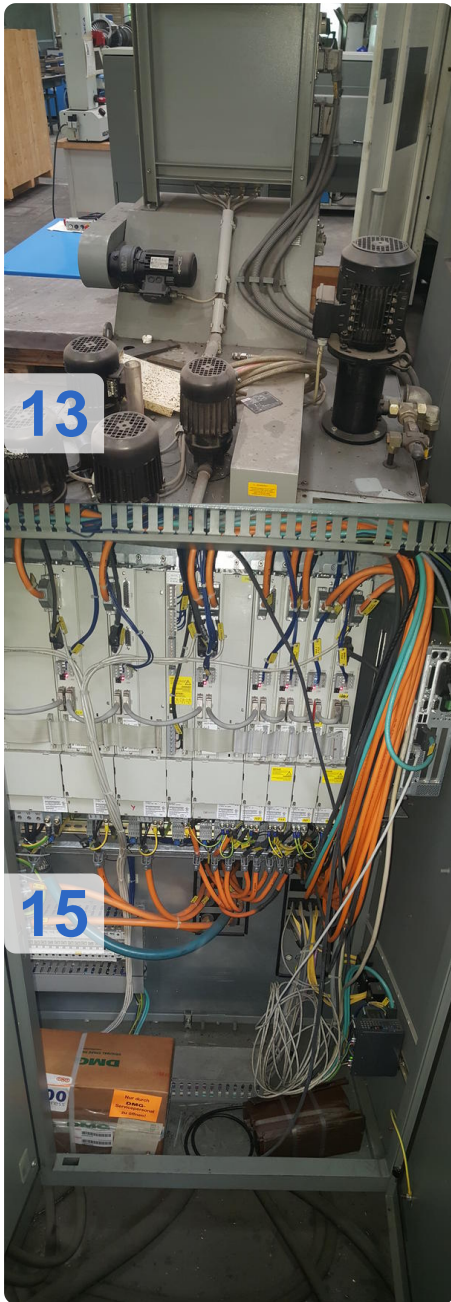

14

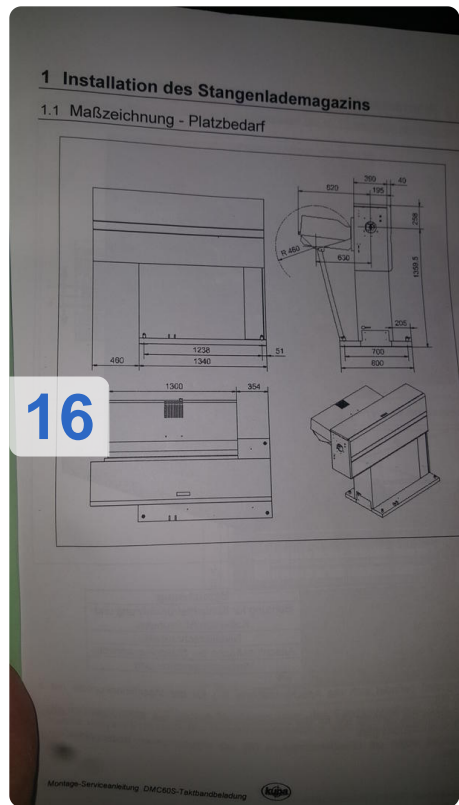



18



20



21

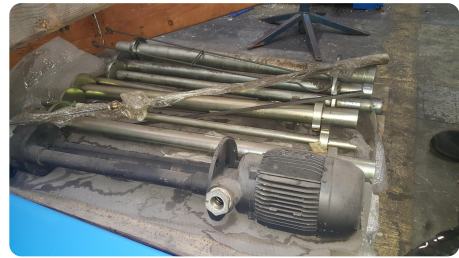

22

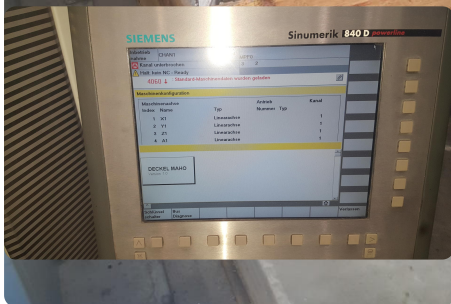

23



24

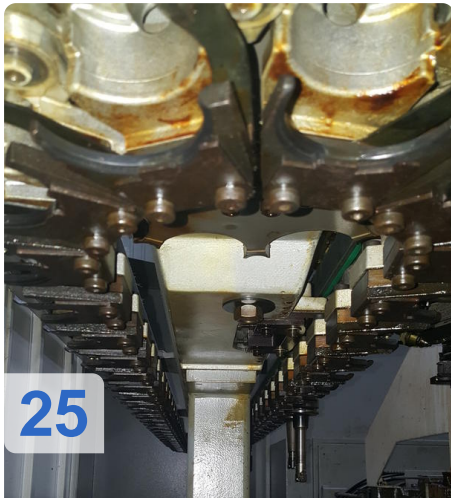

25



27



26



Asset-Trade

Assessment & Sale of Used Assets



Asset-Trade

**Bewertung & Vermarktung von
Industrieanlagen weltweit**

Am Sonnenhof 16

47800 Krefeld

Deutschland

Tel.: +49 2151 32500 33